

Varenummer: 437900200

Beskrivelse: Rota-fix spændelement SA 200

## Mål

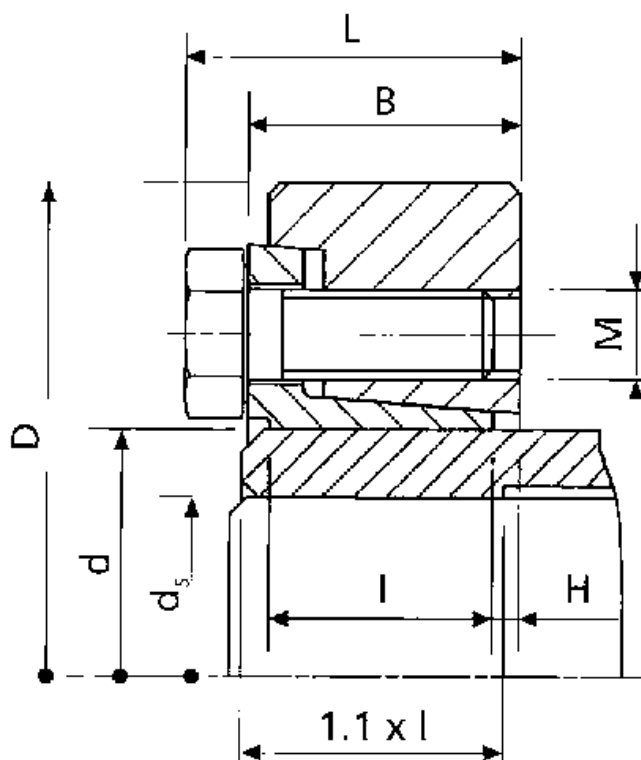

B mm	= 85.5
d H8 mm	= 200
D mm	= 340.0
ds mm	= 150
F kN aksialkraft	= 1093
H	= 8.0
I mm	= 71.5
L mm	= 96.5

M mm	= M16
T Nm drejningsmoment	= 82000
Ts Nm boltetilspændingsmoment	= 250